

***hansen* *neon* gmbh**
technologie - electronic - licht

LED - Light profile





**Light profile in 6 LED colours
- with coloured upper part**

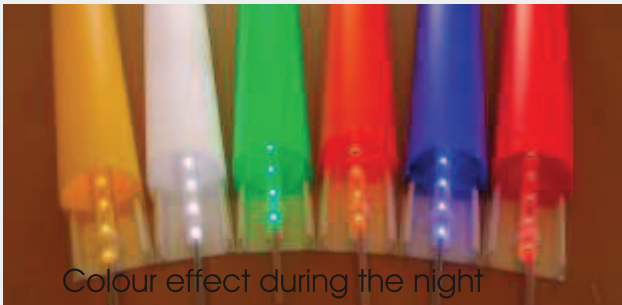

Colour effect during the night



Colour effect during the day

**Light profile in 6 LED colours
- with white upper part**

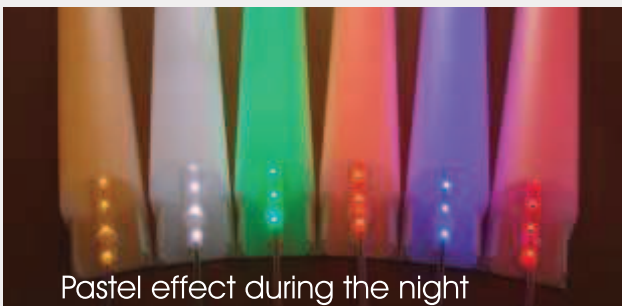

Pastel effect during the night

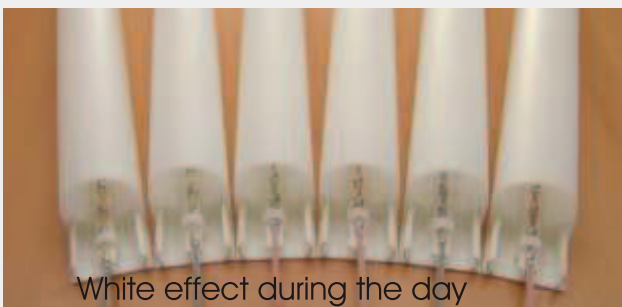

White effect during the day

Illuminated contours can be found in many places on petrol stations and buildings of industrial, commercial and service companies.

Such light bands visually emphasize the contours of a building during the “darker” times of the day from dusk right into the night.

Light contours make buildings stand out from their surrounding and attract attention.

The experience that coloured light increases the observer’s attention formed the basis for the development of our LED Profile.

The individual elements of the profile can be mounted seamlessly to each other creating a continuous light band with a height of 5 cm.

Please contact us for further details and advice!

Advantages of the LED Profile in brief:

- **Uniform, “seamless” light without dark areas**
- **Continuous illuminated lines around edges and corners**
- **Considerable energy savings against fluorescent lamps or neon tubes (approx. 6 Watts/metre)**
- **Easy and inexpensive installation**
- **Proven LED technology with LED tube**
- **Designed for harsh environments**
- **All technical equipment is installed in the base (lower part), i.e. no additional transformers required**
- **Up to 150 m with one single supply point**

6 LED colours:

- **White**
- **Blue**
- **Green**
- **Red**
- **Yellow**
- **Amber**

Available covers (upper part):

- **White (GS 072 similar)**
- **Blue (GS 612 similar)**
- **Green (GS 702 similar)**
- **Red (GS 2713 similar)**
- **Yellow (GS 304 similar)**
- **Amber (GS 410 similar)**

Mixed colours based on two LED colours and RGB colour mixture can also be supplied.

Please ask for details.

□ **Transparent white (GS 010 similar)**
This cover can be fitted with translucent adhesive foil to obtain a variety of additional colours.

Components of the LED Profile

Plastic profile

Lower part (base): white extruded ABS plastic profile. It will be delivered pre-assembled and contains also the electrical internals, i.e. LEDs, converter and cabling.

Upper part (cover): extruded profile made of acrylic (PMMA) with a slightly structured surface, available in different colours. The acrylic material has a very good optical scattering characteristic and converts the punctual LED light into a shadow-free light band.

LED tube

The LED tube serves as the light source and consists of up to 50 series-connected light-emitting diodes (LEDs). This chain of LEDs is enclosed in a transparent shrink-down plastic tube protecting it against atmospheric influence.

Converter

Special electronic ballast for the LED tube converting the mains voltage into the required LED current. The LED Profile is equipped with a tubular converter specially designed for the restricted mounting conditions inside the profile.

Holding clips for LED tube

Snap-in-type plastic clips holding the LED tube and the cables in place. The clips allow the LED tube to be removed for length adjustments and perfect fitting on site.

End caps

End pieces to close the open ends of the profile, available in different colours matching the upper part of the profile.

Mounting brackets for profile base

The spring steel mounting brackets allow safe and efficient mounting of the profile onto building walls.

Sectional view (actual size)

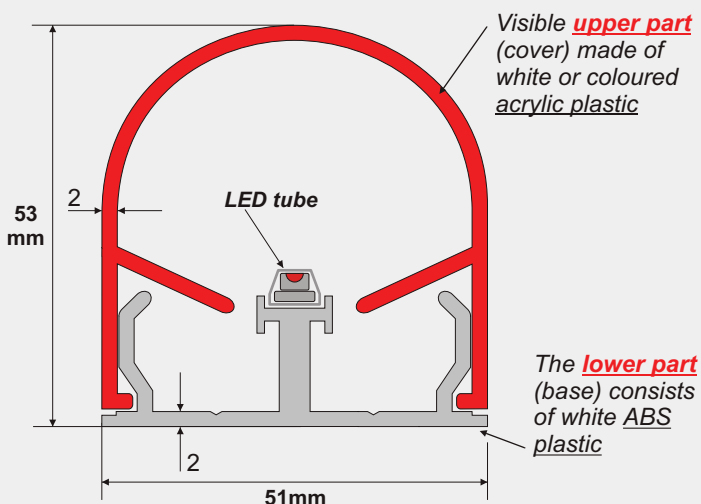

View inside the profile

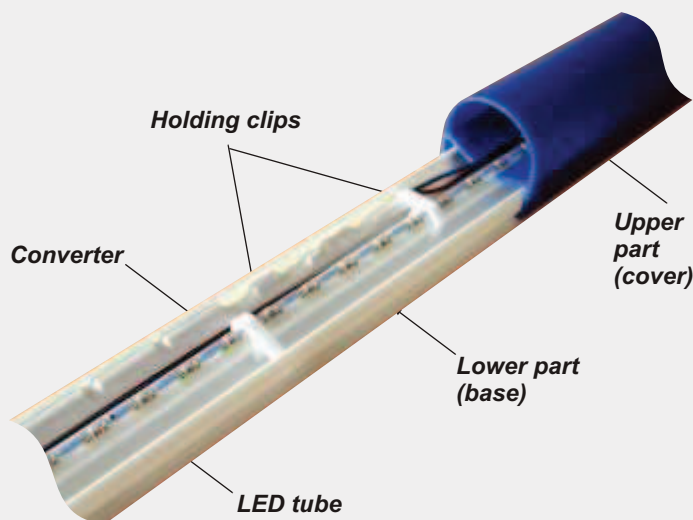

Converter and electrical circuitry

The LEDs are operated in series connection with the current and voltage being supplied by a special converter converting the 230V mains voltage into a DC voltage of 310V (max.).

The LEDs and the converter form a closed electric circuit, which is pre-assembled in the base of the profile. The individual elements available in lengths of 0.5, 1.0 or 2.0 metres can be combined to form a continuous illuminated line of any length.

The only electrical installation work required is to connect the two leads between the individual elements (e.g. using screwless Wago terminals). All the other wiring has already been done in the factory.

Up 150 metres of LED Profile can be operated with one single 230V mains supply point (230V).

Energy consumption:

Power demand per metre LED Profile (approx. values):

LED colour	LED distance: 2 cm
White / blue / green:	6 Watts/m
Red / yellow / amber:	5 Watts/m

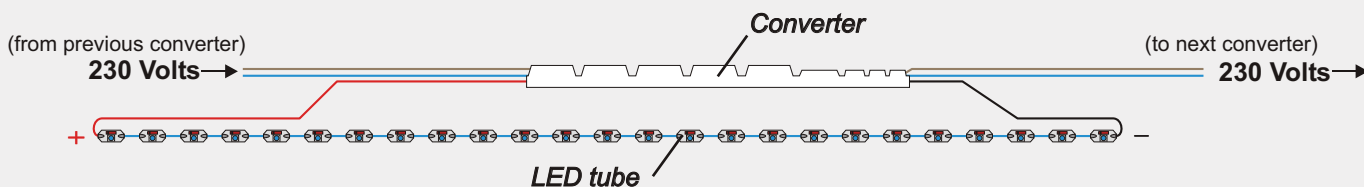

Electrical installation

The LED Profile will be delivered as individual elements with the LED tube and the converter already installed in the base.

There are two leads on either end of the profile to connect the profile to the voltage supply and the individual elements with each other (through-connection). All electrical connections are made by screwless Wago terminals.

Universal installation

The LED profile can be wall-mounted by fixing the base using standard tapping, spax or mounting screws.

Then, the electrical connection is made (see above).

Finally, the cover is pressed onto the base. Additional mitring may be necessary in corners and on edges (see below).

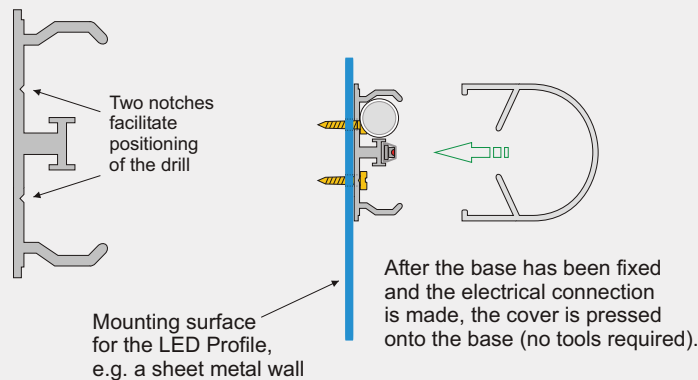

Mitre cutting for edges and corners

Usually, light bands on buildings not only consist of straight sections but also go round corners and edges.

The LED tube can easily be laid around edges. This requires mitre cuts in the visible upper part of the profile (cover).

Most edges are right-angled, but other angles can also be implemented. An example for a 120° edge can be seen on the front page of this brochure (showing the entrance to the Hansen Neon company building).

The mitre cuts should be made on site where the exact lengths can be checked. The precision of a craftsman's portable electric mitre saw is sufficient for this job.

This model shows the possible 90° mitre angles at a glance!

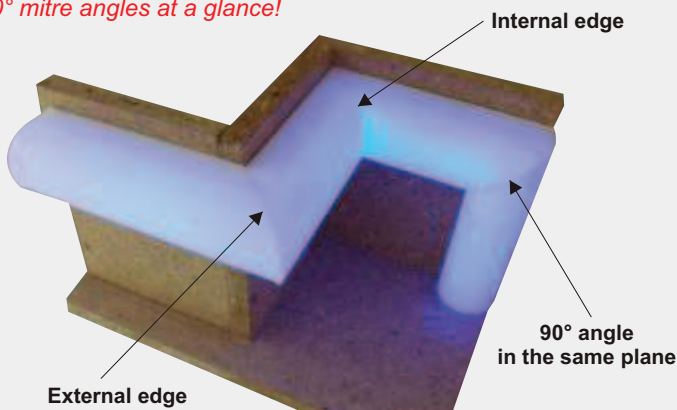

Efficient installation on facades

The LED Profile can easily and cost-efficiently be mounted onto building walls and facades.

For this purpose, we have developed a mounting system with special mounting brackets.

This makes the installation as easy as this:

First, the mounting brackets are fixed to the wall along the centre line of the future light band using plugs and screws. The distance between the brackets should be 50cm. The brackets are equipped with long holes to compensate for any drilling inaccuracies.

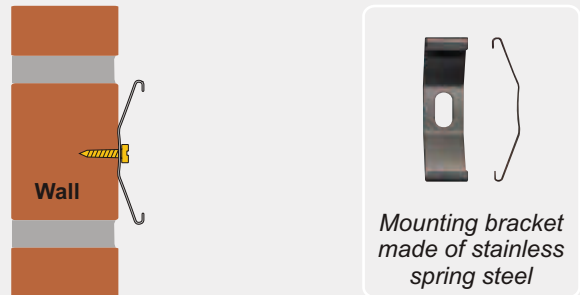

Then the profile bases are fixed by simply clamping them into the mounting brackets (screwless mounting).

Now the factory-prepared mains cables can be connected using Wago terminals (through-connection of the mains voltage).

The LEDs can now be switched on for a check.

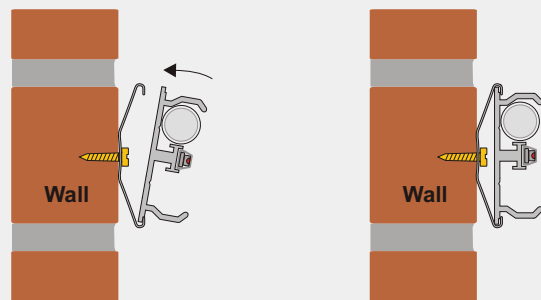

When the connection is made, the covers can be pressed onto the bases. If the profile goes round edges, the cover has to be mitred accordingly.

Finally, the open ends of the profile are closed with the end caps.

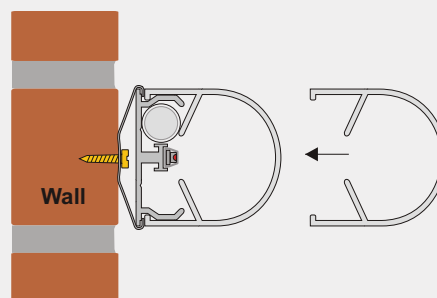

LED Profile (ready for connection)

The LED Profile is supplied as individual pre-assembled elements (including converter and cover).

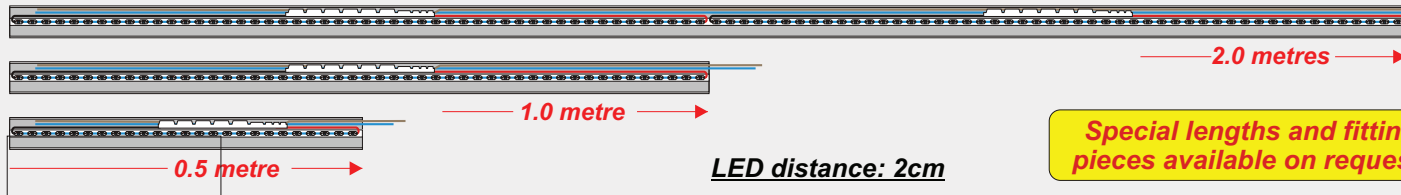

LED light colour	Cover colour	Wavelength (nm)	Power/m (Watts)	Article no. 0.5m element	Article no. 1m element	Article no. 2m element
------------------	--------------	-----------------	-----------------	--------------------------	------------------------	------------------------

Night effect: coloured		Day effect: coloured				
Blue	Blue	460	6	5 5000 116-050	5 5000 116-100	5 5000 116-200
Green	Green	515	6	5 5000 115-050	5 5000 115-100	5 5000 115-200
Red	Red	630	5	5 5000 112-050	5 5000 112-100	5 5000 112-200
Yellow	Yellow	590	5	5 5000 114-050	5 5000 114-100	5 5000 114-200
Amber	Amber	610	5	5 5000 113-050	5 5000 113-100	5 5000 113-200

Night effect: coloured		Day effect: white				
Blue	White	460	6	5 5001 116-050	5 5001 116-100	5 5001 116-200
Green	White	515	6	5 5001 115-050	5 5001 115-100	5 5001 115-200
Red	White	630	5	5 5001 112-050	5 5001 112-100	5 5001 112-200
Yellow	White	590	5	5 5001 114-050	5 5001 114-100	5 5001 114-200
Amber	White	610	5	5 5001 113-050	5 5001 113-100	5 5001 113-200

Night effect: white		Day effect: white				
White	White		6	5 5001 119-050	5 5001 119-100	5 5001 119-200

With adhesive translucent foil:		Night effect: coloured Day effect: coloured				
White	Transparent white		6	5 5002 119-050	5 5002 119-100	5 5002 119-200

Spring steel mounting bracket

Designation	Article no.
Spring steel mounting bracket	5 5000 026



Profile - base (lower part)

Designation	Article no.
Profile - base	5 5000 021

Colour: white



Profil - end caps

Available in black, white or the colour of the respective cover.

Designation	Article no.
Profil - end caps	5 5000 0xx *)

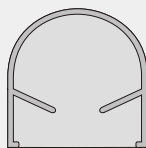

*) Please specify the colour when ordering.

Profile - cover (upper part)

Designation	Article no.
White	5 5000 019-100
Transparent white	5 5000 099-100
Blue	5 5000 016-100
Green	5 5000 115-100
Red	5 5000 112-100
Yellow	5 5000 114-100
Amber	5 5000 118-100

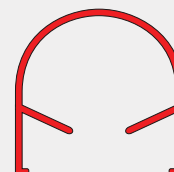

Converter

Type	Article no.	0.5m/ 25 LEDs	1.0m/ 50 LEDs
C 60 P	5 2302 060	Wh / Bl / Gr	
C 90 P	5 2302 090	Rd / Ye / Am	Wh / Bl / Gr Rd / Ye / Am